

The Builder reserves the right to vary dimensions and materials from those on display. Please check plans, specification and addenda carefully. All dimensions to take preference over scaling. COPYRIGHT: This plan shall remain the sole property of the builder and must not be given, lent, resold or otherwise disposed or copied without the permission in writing of the builder.

Wind Rating N1 Coastal Conditions C4

Page	Description
	Cover Page
1.1	Siteplan
1.2	Upper Floor On Site Plan
2.1	Ground Floor
2.2	Upper Floor
3.1	Elevations 1
3.2	Elevations 2
3.3	Elevations 3
3.4	Elevations 4
3.5	3D Perspectives 1
3.6	3D Perspectives 2
3.7	Stairs
4.1	Layout 1
4.2	Layout 2
5.1	Grano Plan
5.2	Slab Edge Check
6.1	Electrical
6.2	Aircon Plan

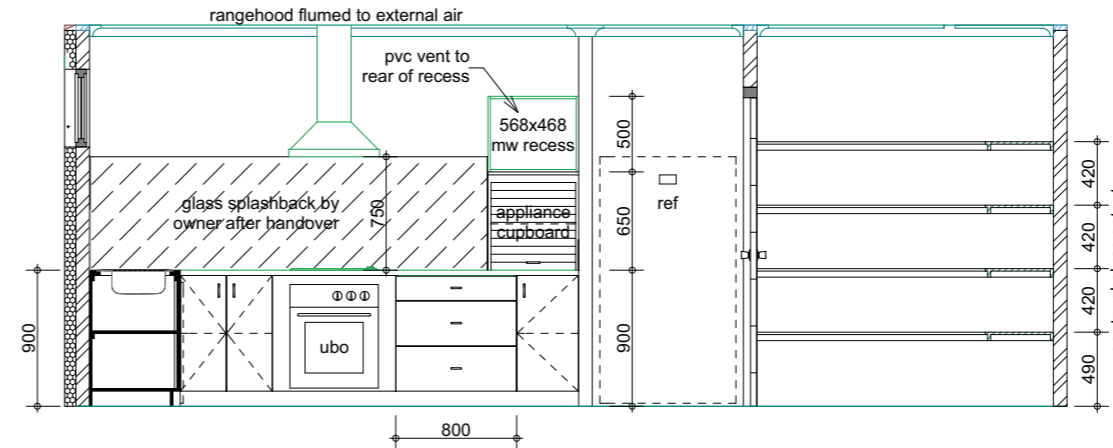
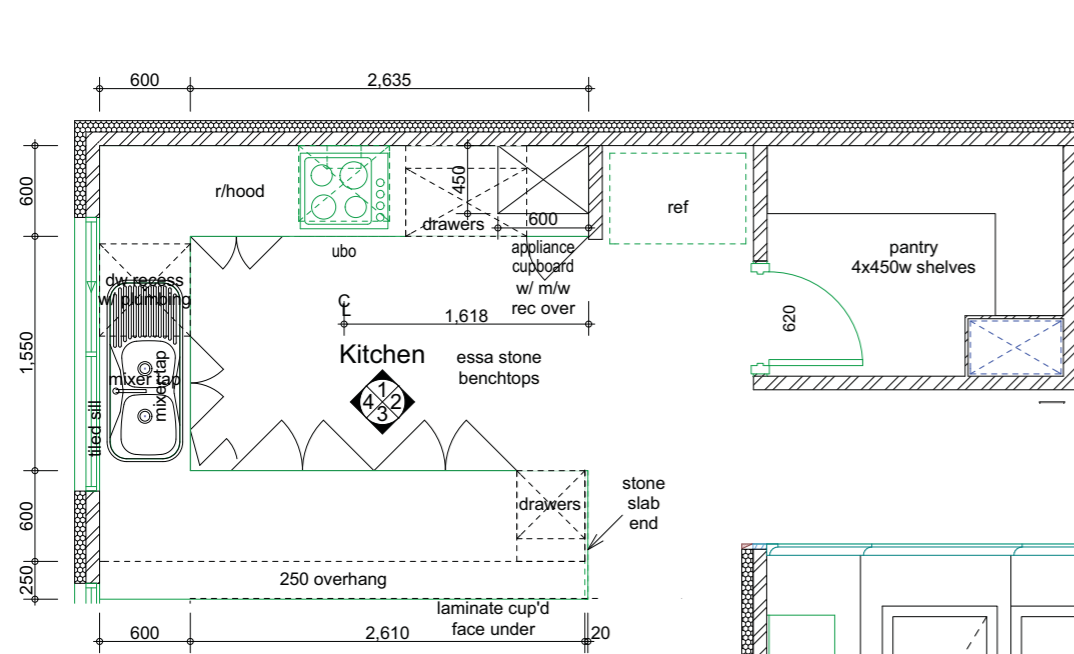

Kitchen 01

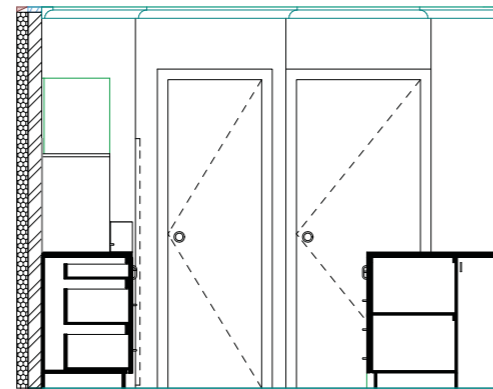

Kitchen 02

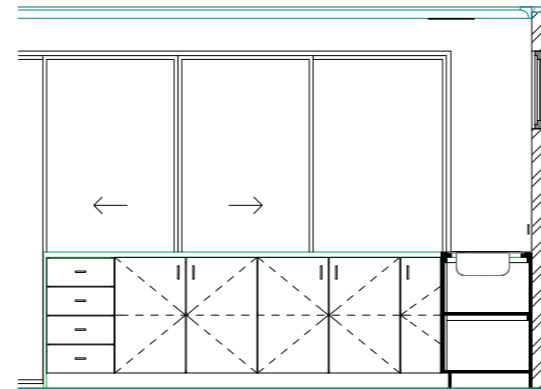

Kitchen 03

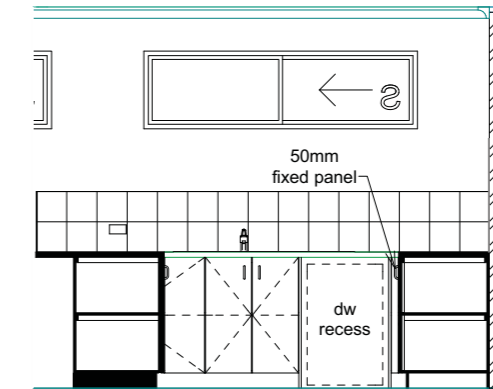

Kitchen 04

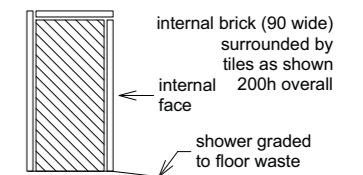

Tiled Hob Detail WAT1.2

Tile heights and positions are nominal only

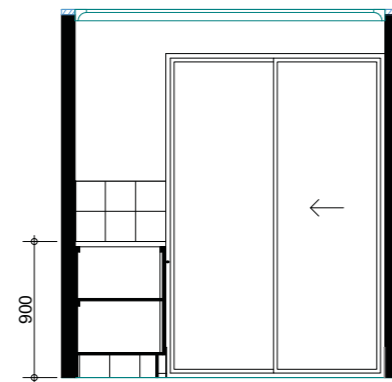
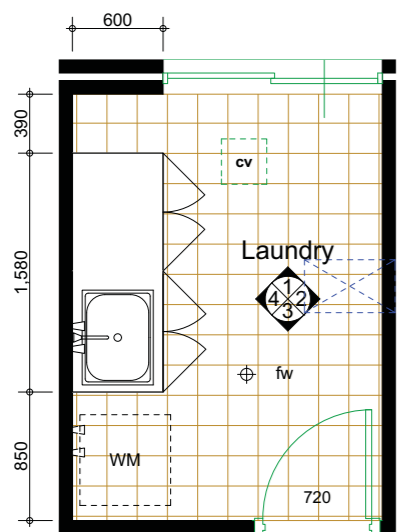

Laundry 01

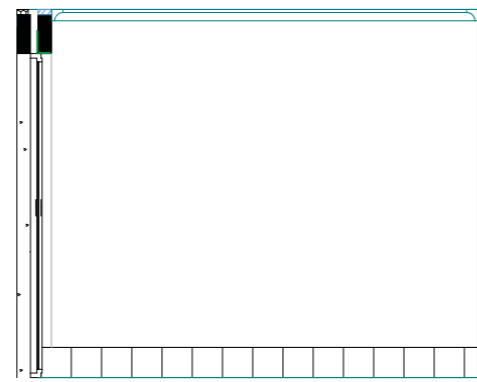

Laundry 02

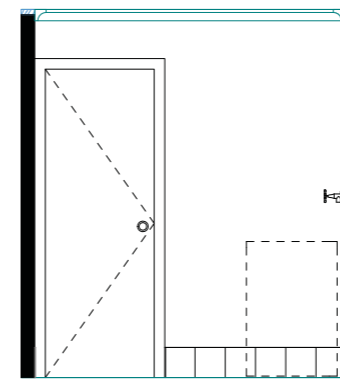

Laundry 03

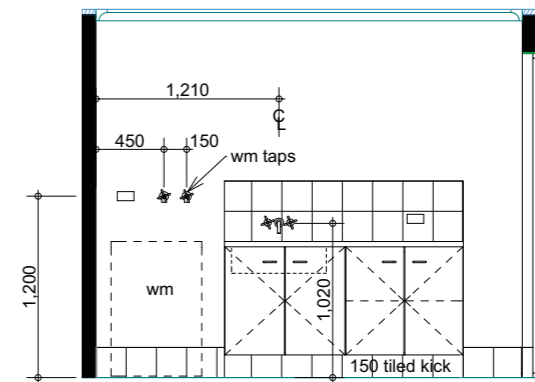

Laundry 04

Revision History:  
PJ 01/01/2011 Sample

Copyright Comet Bay Design 2010  
This plan is the sole property of "Comet Bay Design" and must not be used without written permission from Comet Bay Design.

**Layout 1**

Version : Ver 1 Scale 1:50  
Page : 4.1

**Sample Lot 2 Sample Drive Sample**

Owner 1 : \_\_\_\_\_

Owner 2 : \_\_\_\_\_

Builder: \_\_\_\_\_

Date: \_\_\_\_\_

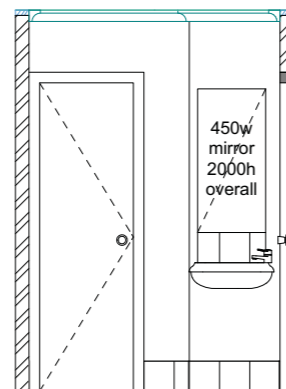
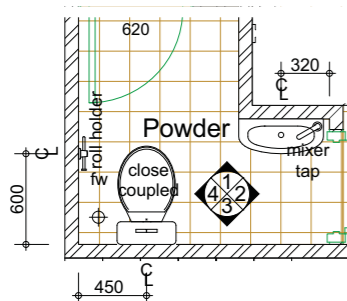

Powder 01

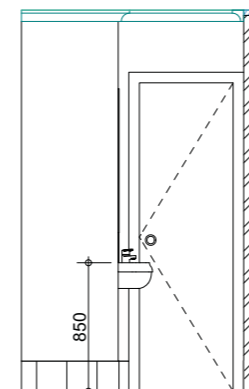

Powder 02

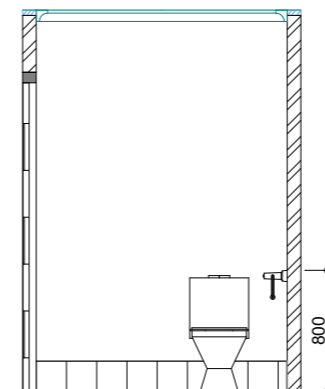

Powder 03

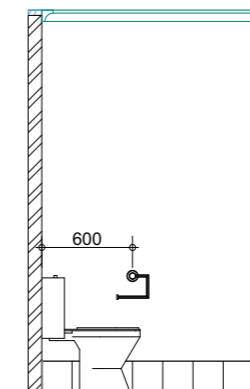

Powder 04

The Builder reserves the right to vary dimensions and materials from those on display. Please check plans, specification and addenda carefully.  
All dimensions to take preference over scaling. COPYRIGHT: This plan shall remain the sole property of the builder and must not be given, lent, resold or otherwise disposed or copied without the permission in writing of the builder.

Wind Rating N1 Coastal Conditions C4

Page	Description
	Cover Page
1.1	Siteplan
1.2	Upper Floor On Site Plan
2.1	Ground Floor
2.2	Upper Floor
3.1	Elevations 1
3.2	Elevations 2
3.3	Elevations 3
3.4	Elevations 4
3.5	3D Perspectives 1
3.6	3D Perspectives 2
3.7	Stairs
4.1	Layout 1
4.2	Layout 2
5.1	Grano Plan
5.2	Slab Edge Check
6.1	Electrical
6.2	Aircon Plan

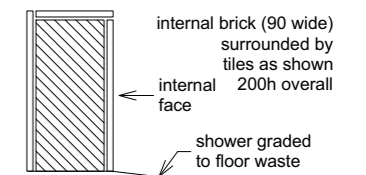

**Tiled Hob Detail** WAT1.2

Revision History:  
PJ 01/01/2011 Sample

Copyright Comet Bay Design 2010  
This plan is the sole property of "Comet Bay Design" and must not be used without written permission from Comet Bay Design.

**Layout 2**

Version : Ver 1 Scale 1:50  
Page : 4.2

**Sample Lot 2 Sample Drive Sample**

Owner 1 : \_\_\_\_\_

Owner 2 : \_\_\_\_\_

Builder: \_\_\_\_\_

Date: \_\_\_\_\_

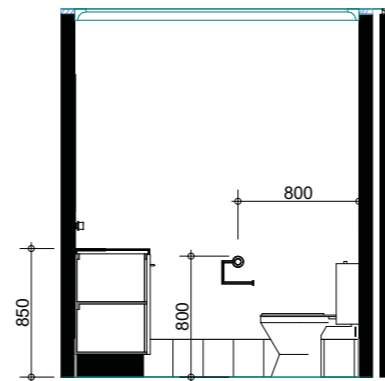
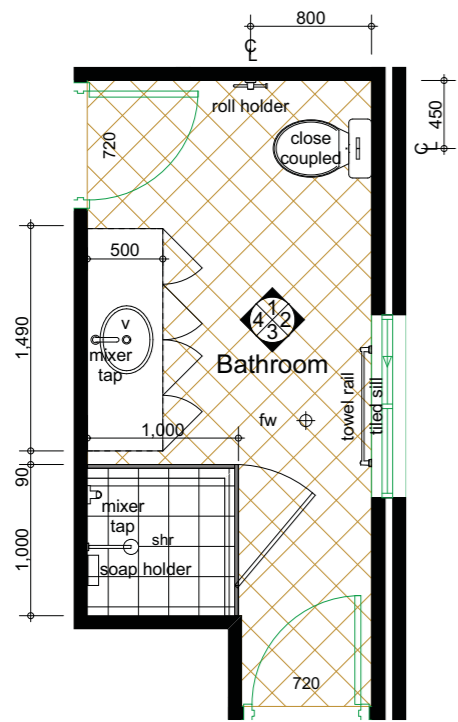

**Bath 01**

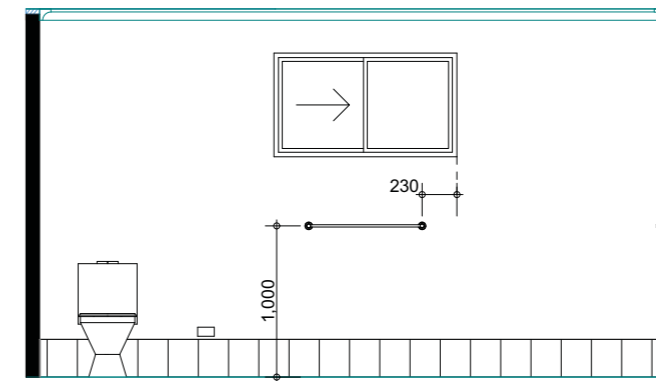

**Bath 02**

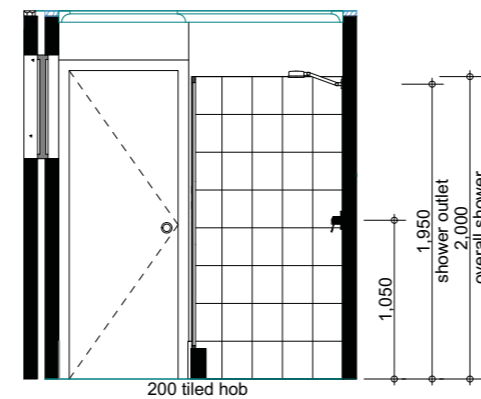

**Bath 03**

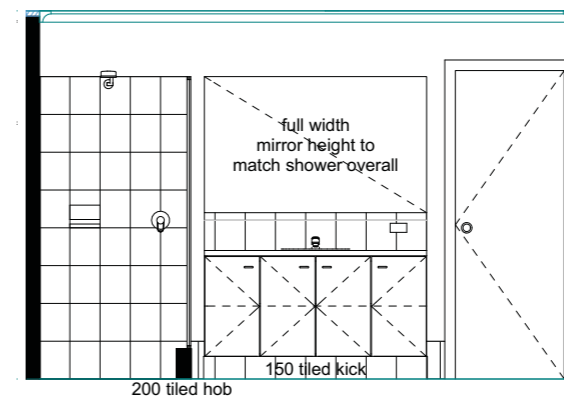

**Bath 04**

Tile heights and positions are nominal only

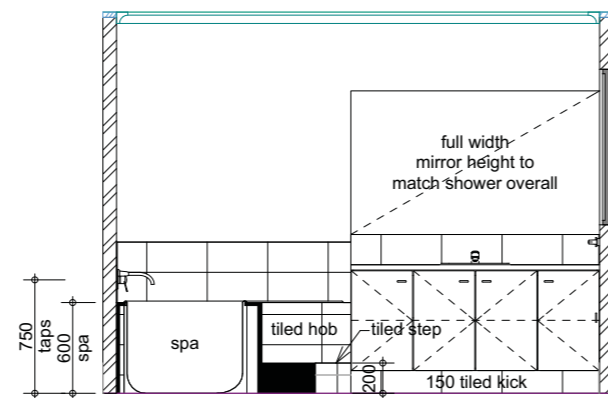
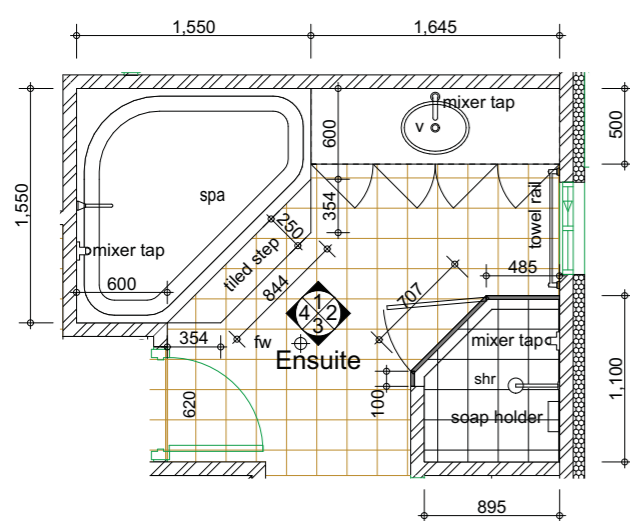

**Ensuite 01**

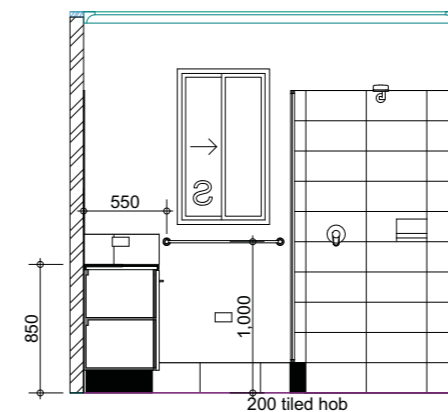

**Ensuite 02**

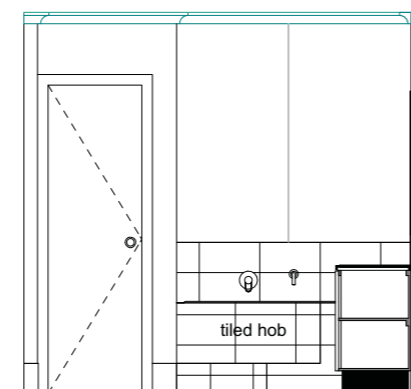

**Ensuite 04**

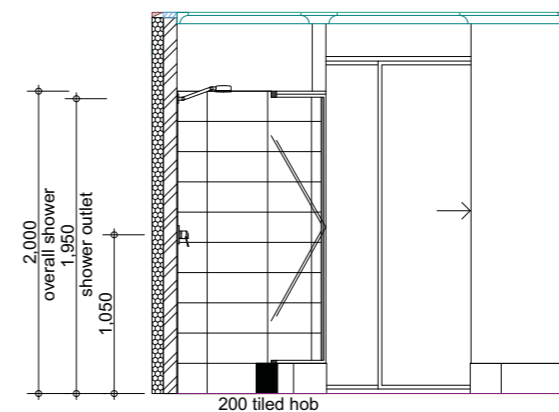

**Ensuite 03**

Page	Wind Rating N1	Coastal Conditions C4	Description
1.1			Cover Page
1.2			Siteplan
2.1			Upper Floor On Site Plan
2.2			Ground Floor
3.1			Upper Floor
3.2			Elevations 1
3.3			Elevations 2
3.4			Elevations 3
3.5			Elevations 4
3.6			3D Perspectives 1
3.7			3D Perspectives 2
4.1			Stairs
4.2			Layout 1
5.1			Layout 2
5.2			Grano Plan
6.1			Slab Edge Check
6.2			Electrical
			Aircon Plan

Revision History:  
PJ 01/01/2011 Sample

Copyright Comet Bay Design 2010  
This plan is the sole property of "Comet Bay Design" and must not be used without written permission from Comet Bay Design

Version : Ver 1 | Scale 1:100

Page : 5.1

**Sample**  
**Lot 2 Sample Drive**  
**Sample**

Owner 1 : \_\_\_\_\_  
Owner 2 : \_\_\_\_\_  
Builder : \_\_\_\_\_  
Date : \_\_\_\_\_

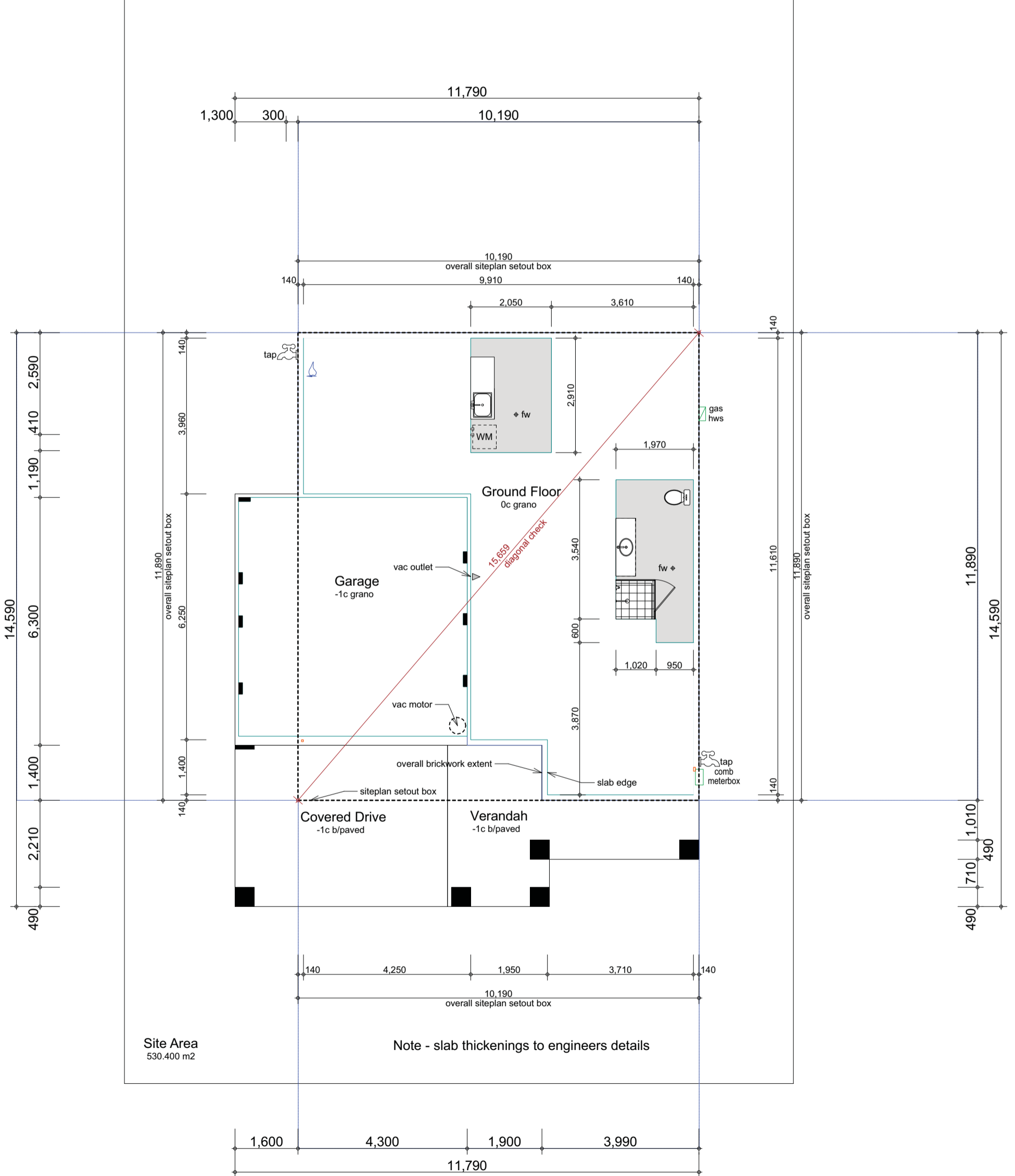

Note - slab thickenings to engineers details