

Elevation 1

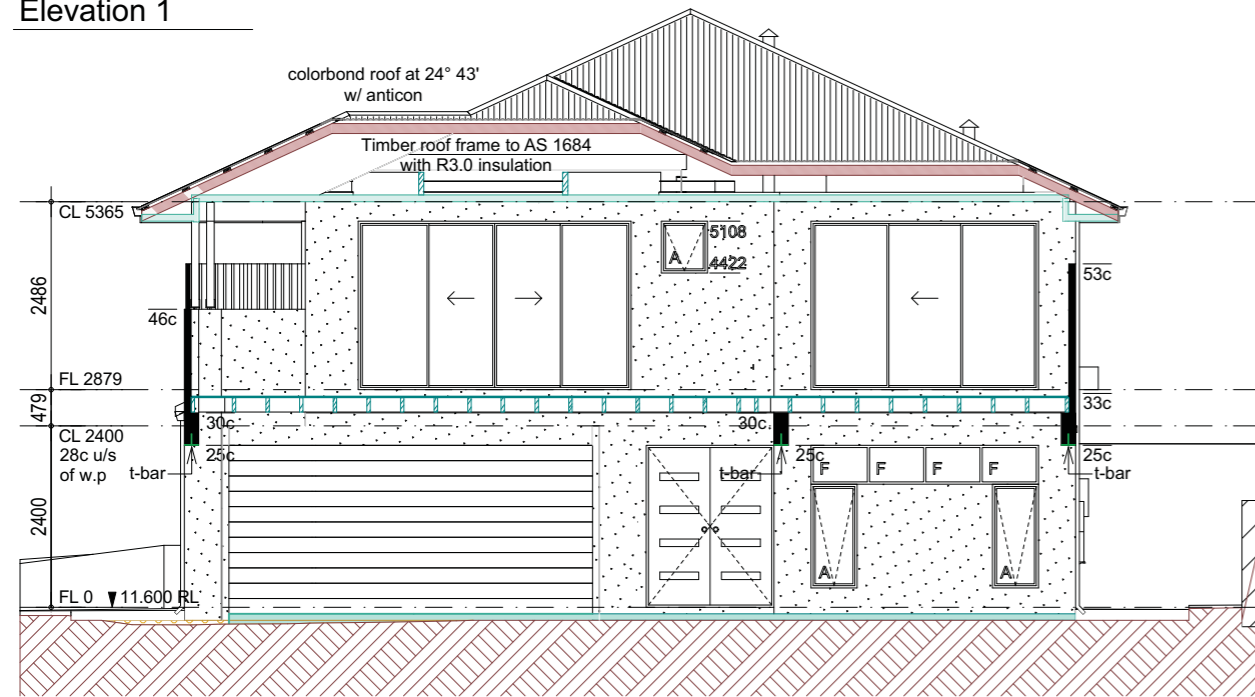

A1 Section

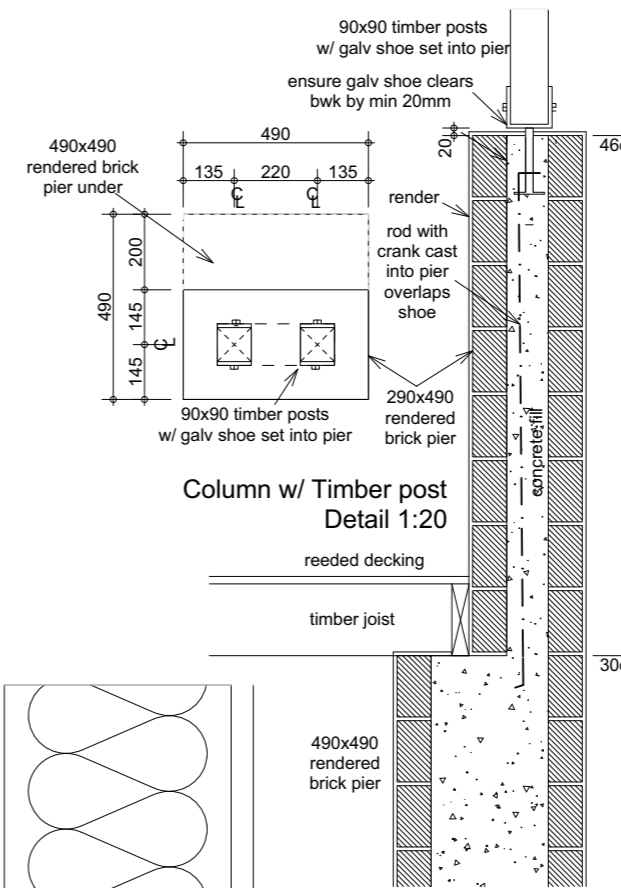
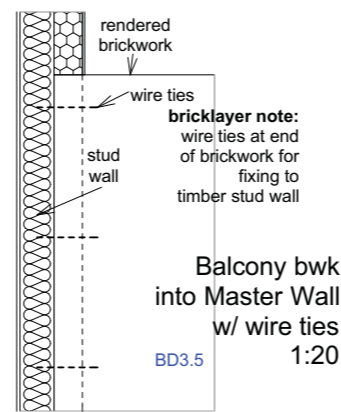
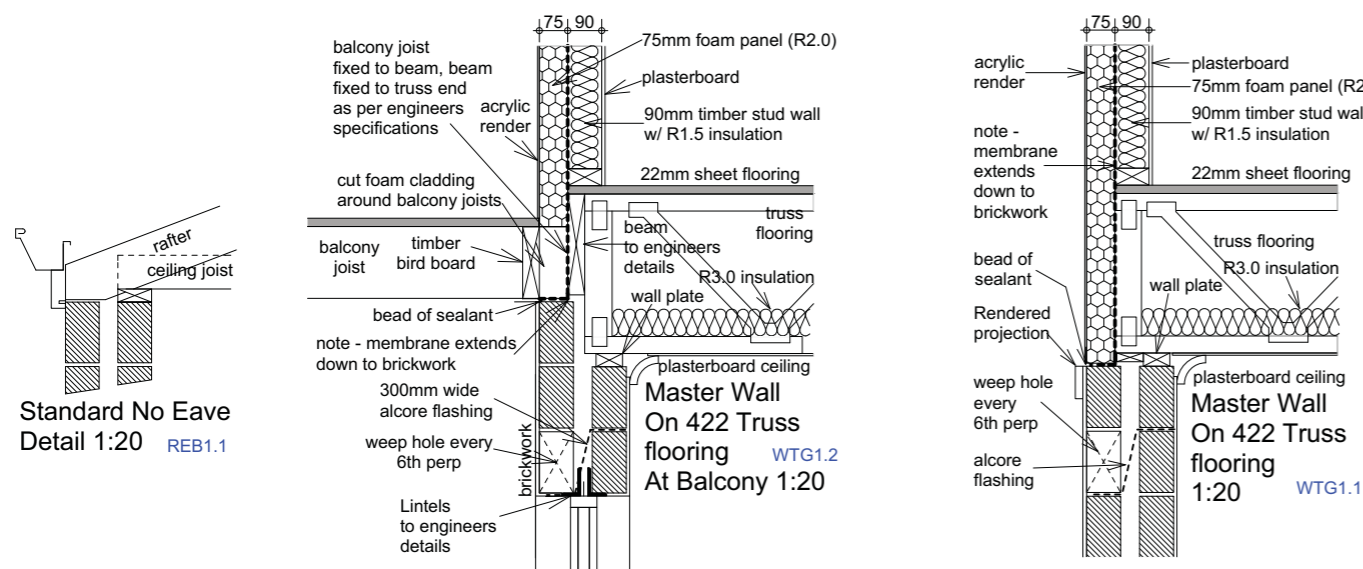

Legend (not to scale)

- natural ground
- extent of sand fill
- 30° sloping embankment
- new retaining (cut)
- new retaining (elevation)
- new cavity filled retaining
- existing retaining

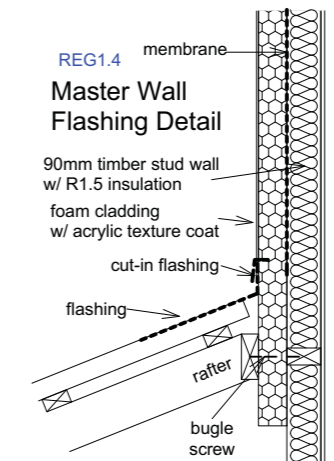
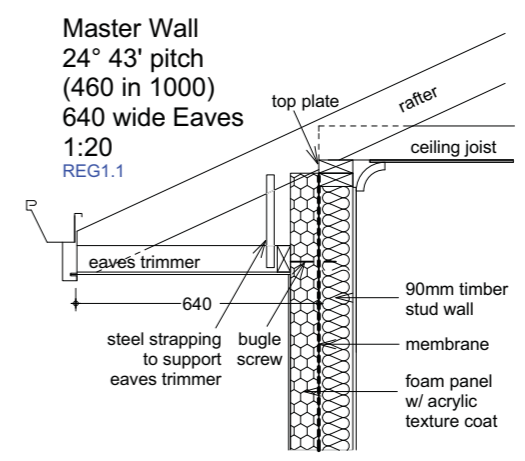
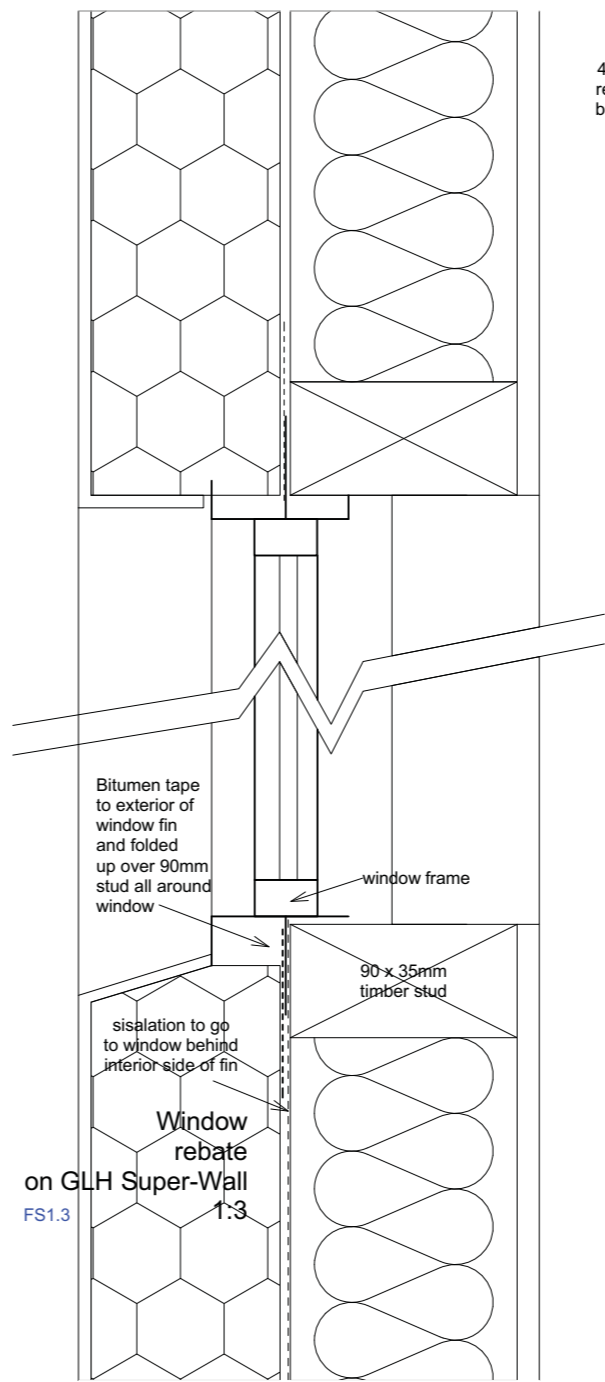

Wind Rating N1 Coastal Conditions C4

Page	Description
1.1	Cover Page
1.2	Siteplan
2.1	Upper Floor On Site Plan
2.2	Ground Floor
2.3	Upper Floor
3.1	Elevations 1
3.2	Elevations 2
3.3	Elevations 3
3.4	Elevations 4
3.5	3D Perspectives 1
3.6	3D Perspectives 2
3.7	Stairs
4.1	Layout 1
4.2	Layout 2
5.1	Grano Plan
5.2	Slab Edge Check
6.1	Electrical
6.2	Aircon Plan

Revision History:

PJ 01/01/2011	Sample
---------------	--------

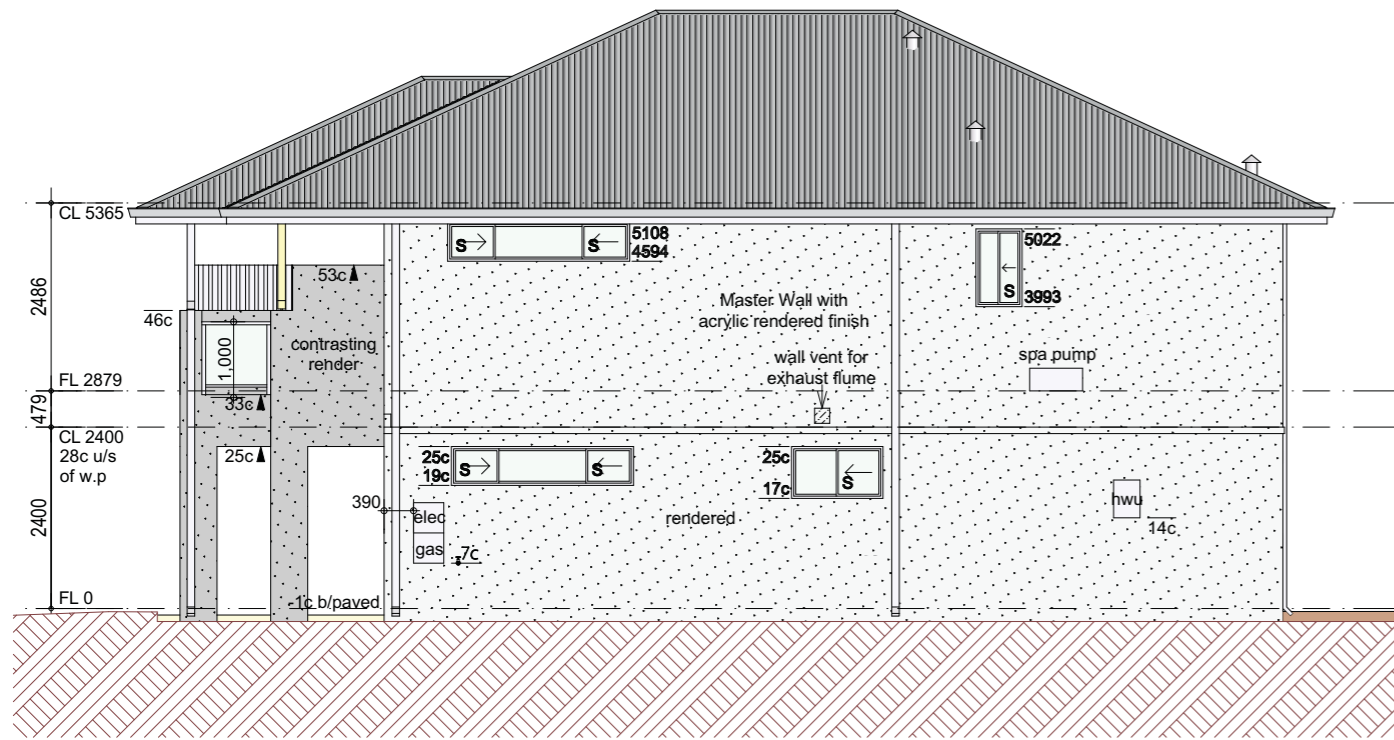

Elevation 2

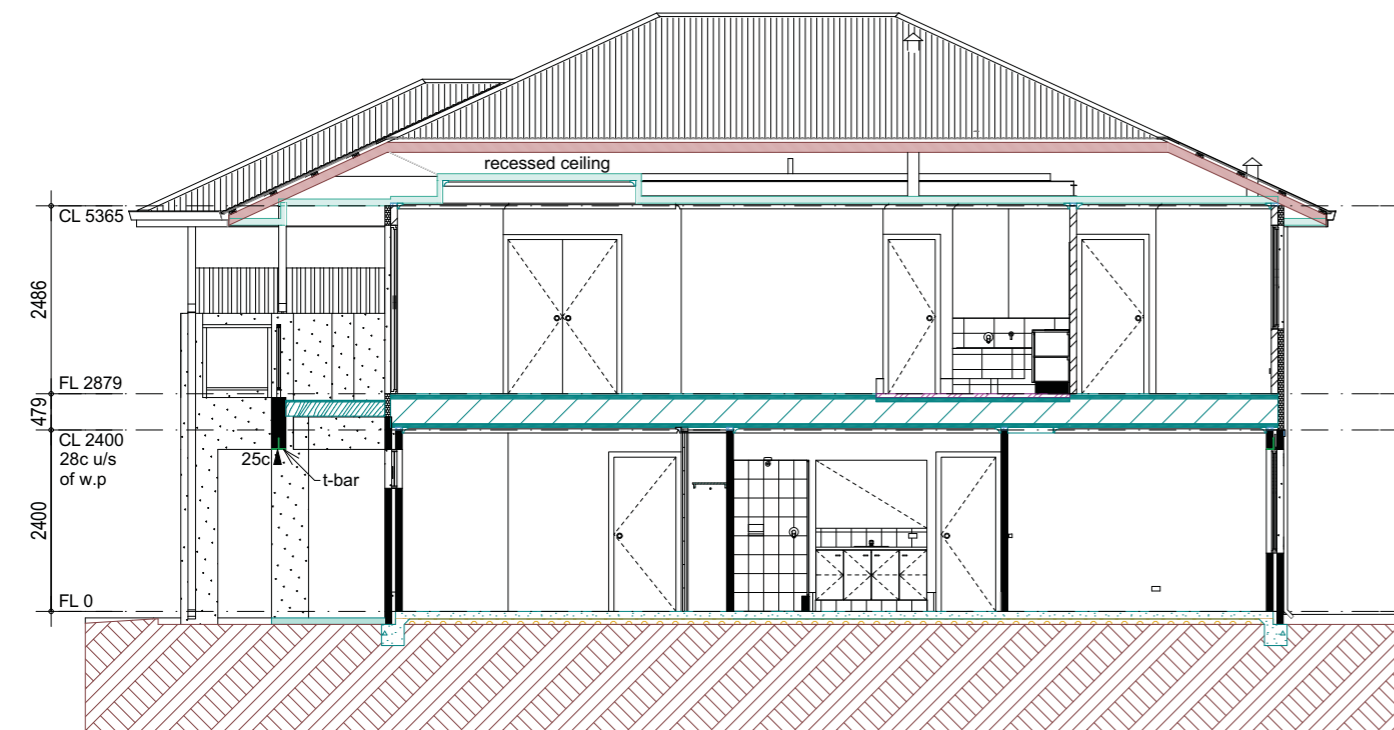

A2 Section

Legend (not to scale)

- natural ground
- extent of sand fill
- 30° sloping embankment
- new retaining (cut)
- new retaining (elevation)
- new cavity filled retaining
- existing retaining

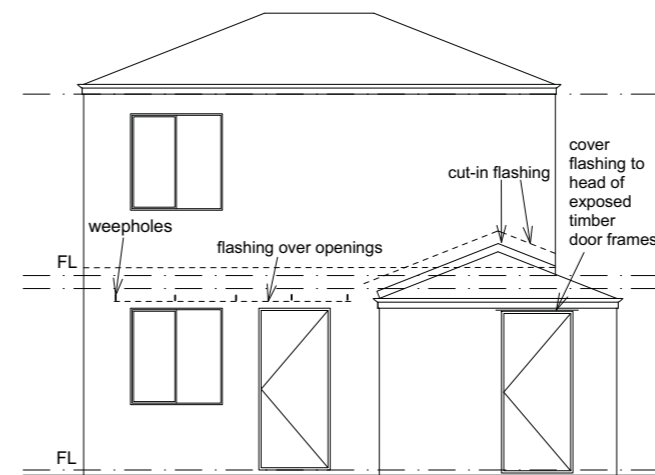

Sample Flashing Detail FS1.2

The Builder reserves the right to vary dimensions and materials from those on display. Please check plans, specification and addenda carefully. All dimensions to take preference over scaling. COPYRIGHT: This plan shall remain the sole property of the builder and must not be given, lent, resold or otherwise disposed or copied without the permission in writing of the builder.

Wind Rating N1 Coastal Conditions C4

Page	Description
	Cover Page
1.1	Siteplan
1.2	Upper Floor On Site Plan
2.1	Ground Floor
2.2	Upper Floor
3.1	Elevations 1
3.2	Elevations 2
3.3	Elevations 3
3.4	Elevations 4
3.5	3D Perspectives 1
3.6	3D Perspectives 2
3.7	Stairs
4.1	Layout 1
4.2	Layout 2
5.1	Grano Plan
5.2	Slab Edge Check
6.1	Electrical
6.2	Aircon Plan

Revision History:

PJ	01/01/2011	Sample
----	------------	--------

© Copyright Comet Bay Design 2010
This plan is the sole property of "Comet Bay Design" and must not be used without written permission from Comet Bay Design

Elevations 2

Version :	Ver 1	Scale 1:20, 1:100, 1:50
Page :	3.2	

**Sample
Lot 2 Sample Drive
Sample**

Owner 1 : _____

Owner 2 : _____

Builder: _____

Date: _____

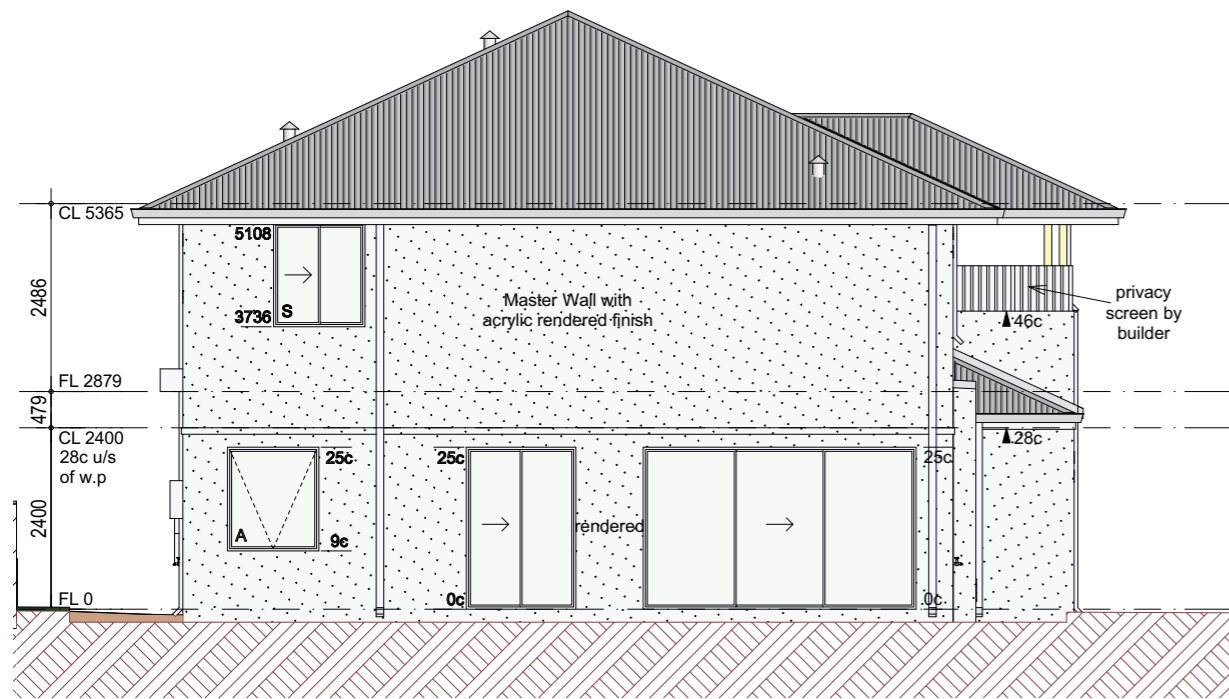

Elevation 3

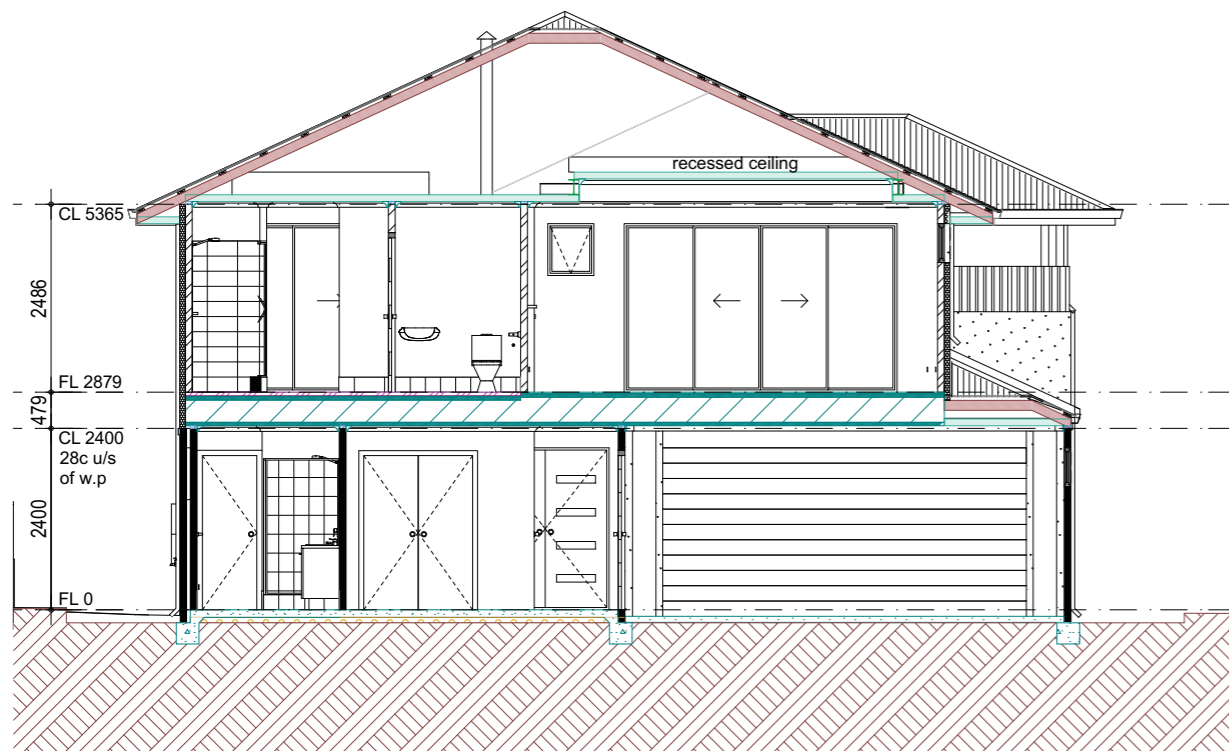

A3 Section

Legend (not to scale)

- natural ground
- extent of sand fill
- 30° sloping embankment
- new retaining (cut)
- new retaining (elevation)
- new cavity filled retaining
- existing retaining

The Builder reserves the right to vary dimensions and materials from those on display. Please check plans, specification and addenda carefully. All dimensions to take preference over scaling. COPYRIGHT: This plan shall remain the sole property of the builder and must not be given, lent, resold or otherwise disposed or copied without the permission in writing of the builder.

Wind Rating N1 Coastal Conditions C4

Page	Description
	Cover Page
1.1	Siteplan
1.2	Upper Floor On Site Plan
2.1	Ground Floor
2.2	Upper Floor
3.1	Elevations 1
3.2	Elevations 2
3.3	Elevations 3
3.4	Elevations 4
3.5	3D Perspectives 1
3.6	3D Perspectives 2
3.7	Stairs
4.1	Layout 1
4.2	Layout 2
5.1	Grano Plan
5.2	Slab Edge Check
6.1	Electrical
6.2	Aircon Plan

Revision History:

PJ 01/01/2011	Sample
---------------	--------

© Copyright Comet Bay Design 2010
This plan is the sole property of "Comet Bay Design" and must not be used without written permission from Comet Bay Design

Elevations 3
Version : Ver 1 Scale 1:100, 1:20
Page : 3.3

Sample Lot 2 Sample Drive Sample

Owner 1 : _____
Owner 2 : _____
Builder: _____
Date: _____

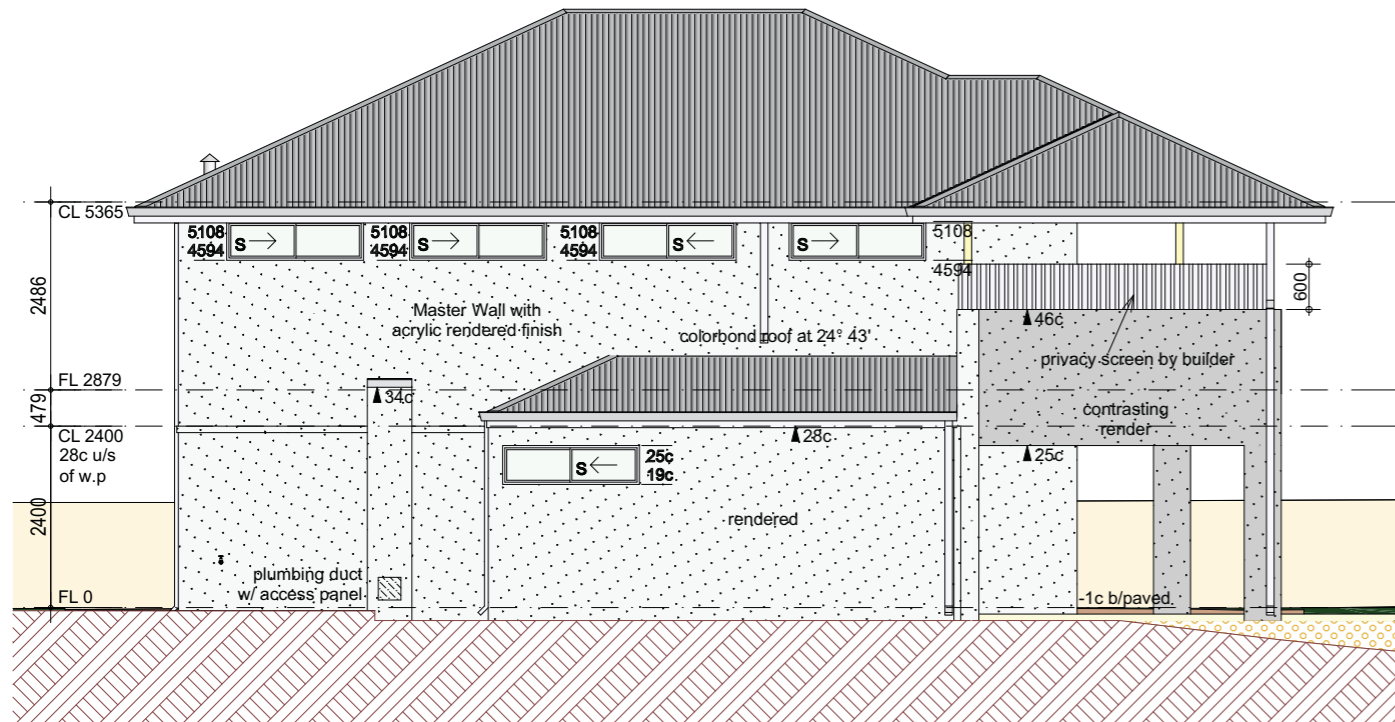

Elevation 4

Legend (not to scale)

- natural ground
- extent of sand fill
- 30° sloping embankment
- new retaining (cut)
- new retaining (elevation)
- new cavity filled retaining
- existing retaining

The Builder reserves the right to vary dimensions and materials from those on display. Please check plans, specification and addenda carefully. All dimensions to take preference over scaling. COPYRIGHT: This plan shall remain the sole property of the builder and must not be given, lent, resold or otherwise disposed or copied without the permission in writing of the builder.

Wind Rating N1 Coastal Conditions C4

Page	Description
	Cover Page
1.1	Siteplan
1.2	Upper Floor On Site Plan
2.1	Ground Floor
2.2	Upper Floor
3.1	Elevations 1
3.2	Elevations 2
3.3	Elevations 3
3.4	Elevations 4
3.5	3D Perspectives 1
3.6	3D Perspectives 2
3.7	Stairs
4.1	Layout 1
4.2	Layout 2
5.1	Grano Plan
5.2	Slab Edge Check
6.1	Electrical
6.2	Aircon Plan

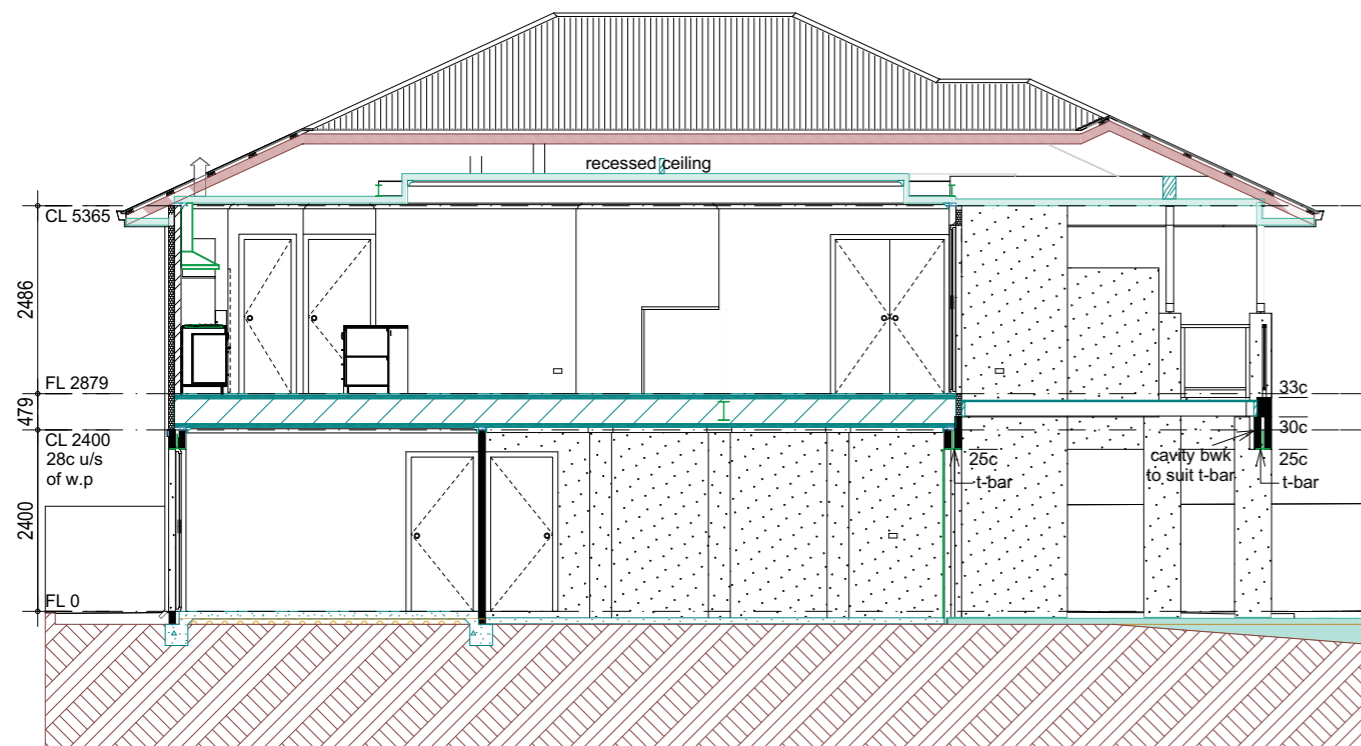

A4 Section

Revision History:

PJ	01/01/2011	Sample
----	------------	--------

© Copyright Comet Bay Design 2010
This plan is the sole property of "Comet Bay Design" and must not be used without written permission from Comet Bay Design

Elevations 4
Version : Ver 1 Scale 1:20, 1:100
Page : 3.4

Sample Lot 2 Sample Drive Sample

Owner 1 : _____
Owner 2 : _____
Builder: _____
Date: _____